

Onyx Grade 80 Component Connector

Code : OXCC13

Chain Dia. : 13mm

ONYX

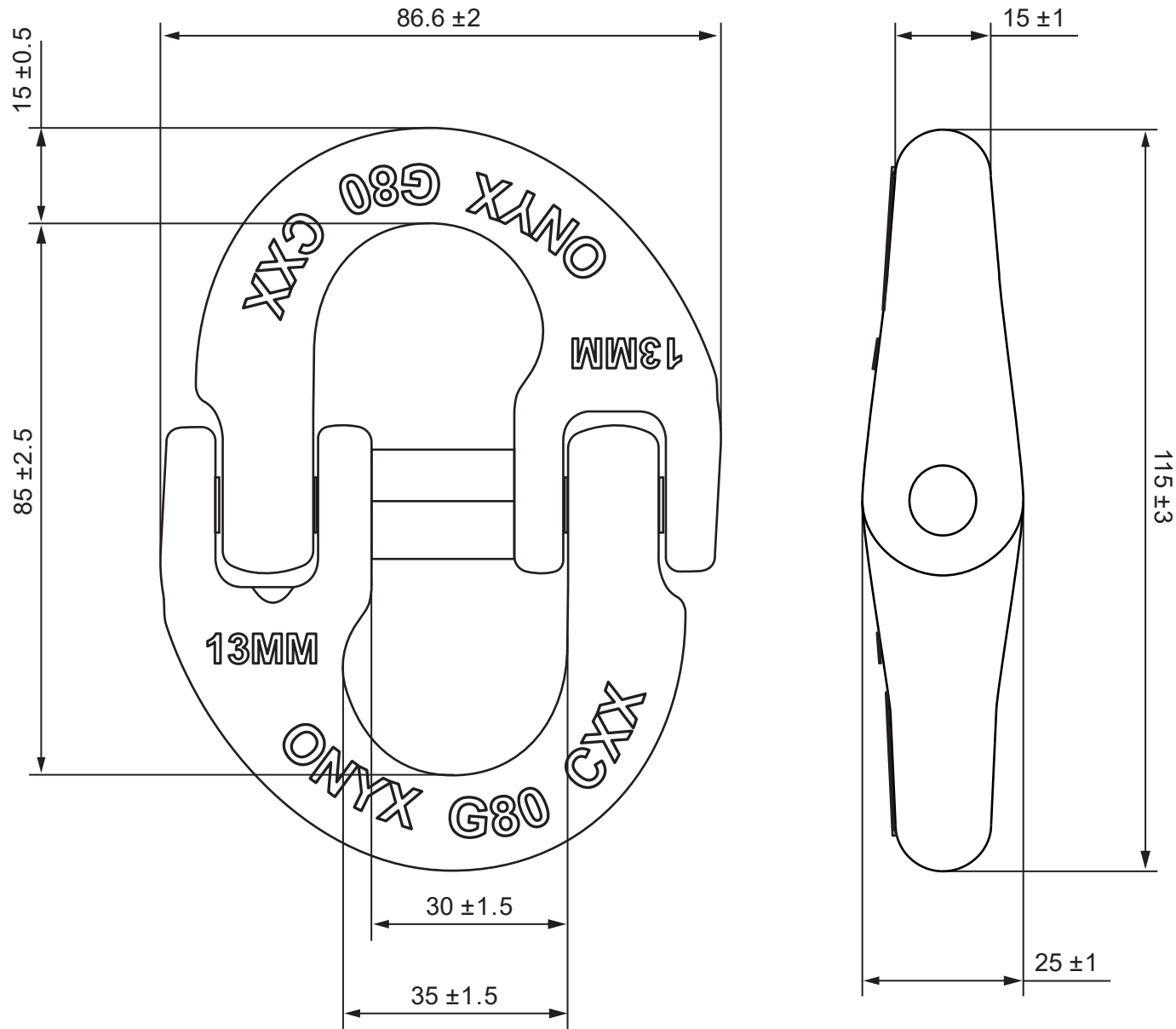

We reserve the right to make ammendments on specifications in this drawing without prior notification.

GEORGE TAYLOR LIFTING GEAR
UNIT 4, FRYERS ROAD,
WALSALL WS2 7LZ



Drawing Number
OXCC13-GTTD

Format
A4

Drawn by
Josh Ranford

Copyright by George Taylor & Co. Lifting Gear (Midlands) Ltd. All rights reserved ©.
This document or any part of it may neither be used for any purpose other than that
for which it is specifically designed, without the prior written consent of GT.

Part name:
OXCC13

Scale
1:1

Part No. / ID
OXCC13

Page
1/1

06.11.23

First Issue