

Onyx Grade 80 Eyenut
 Code : OXEN16
 Dia. : 16mm

ONYX

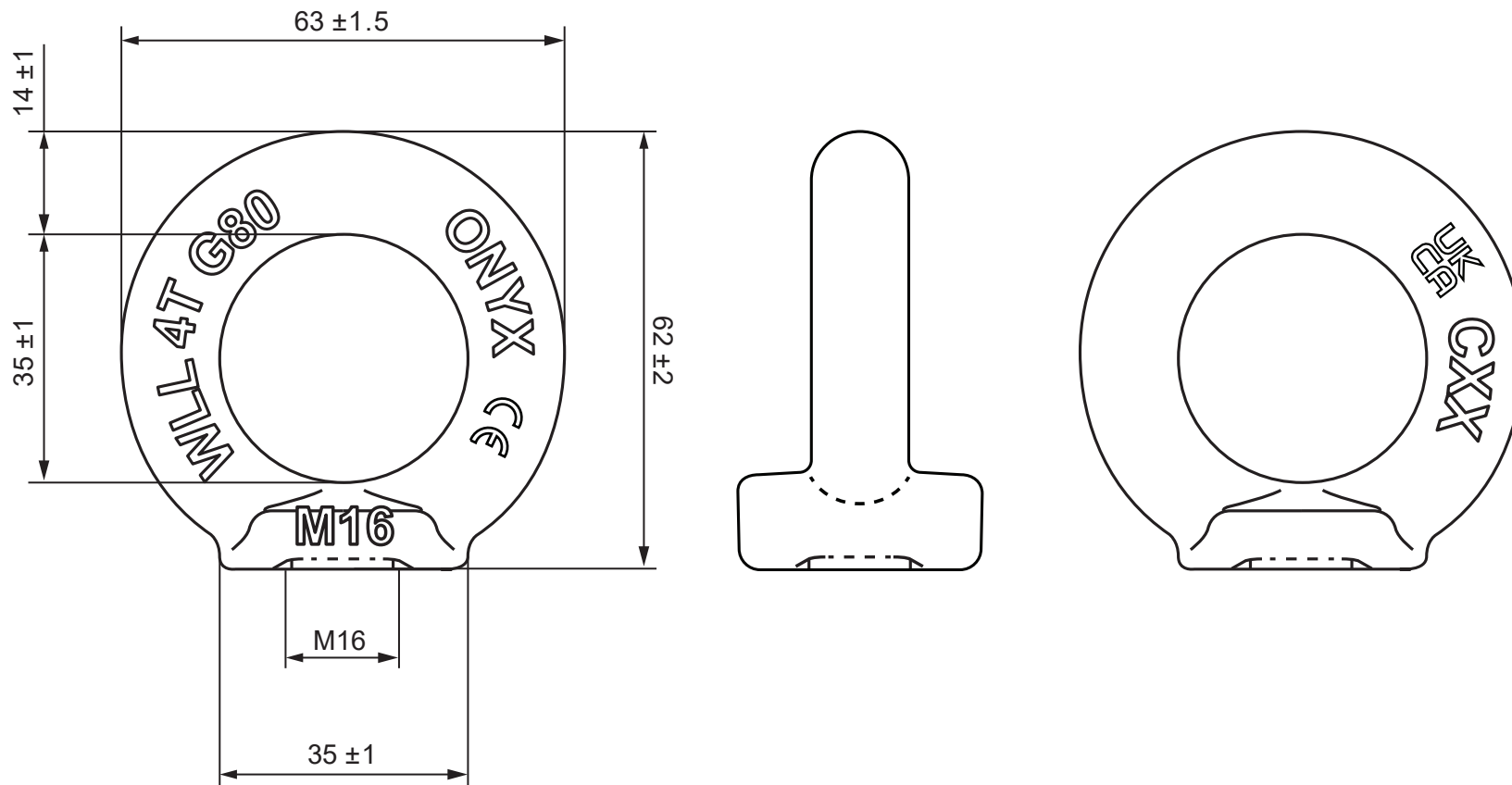

We reserve the right to make ammendments on specifications in this drawing without prior notification.

GEORGE TAYLOR LIFTING GEAR
 UNIT 4, FRYERS ROAD,
 WALSALL WS2 7LZ



Drawing Number
OXEN16-GTTD

Format
A4

Drawn by

Josh Ranford

Copyright by George Taylor & Co. Lifting Gear (Midlands) Ltd. All rights reserved ©.
 This document or any part of it may neither be used for any purpose other than that for which it is specifically designed, without the prior written consent of GT.

Part name:
OXEN16

Scale
1:1

Page

1/1

15.02.24

First Issue