

Onyx Grade 80 Master Link 20B6

Code : OXML20B6

WLL : 6,400 kgs

ONYX

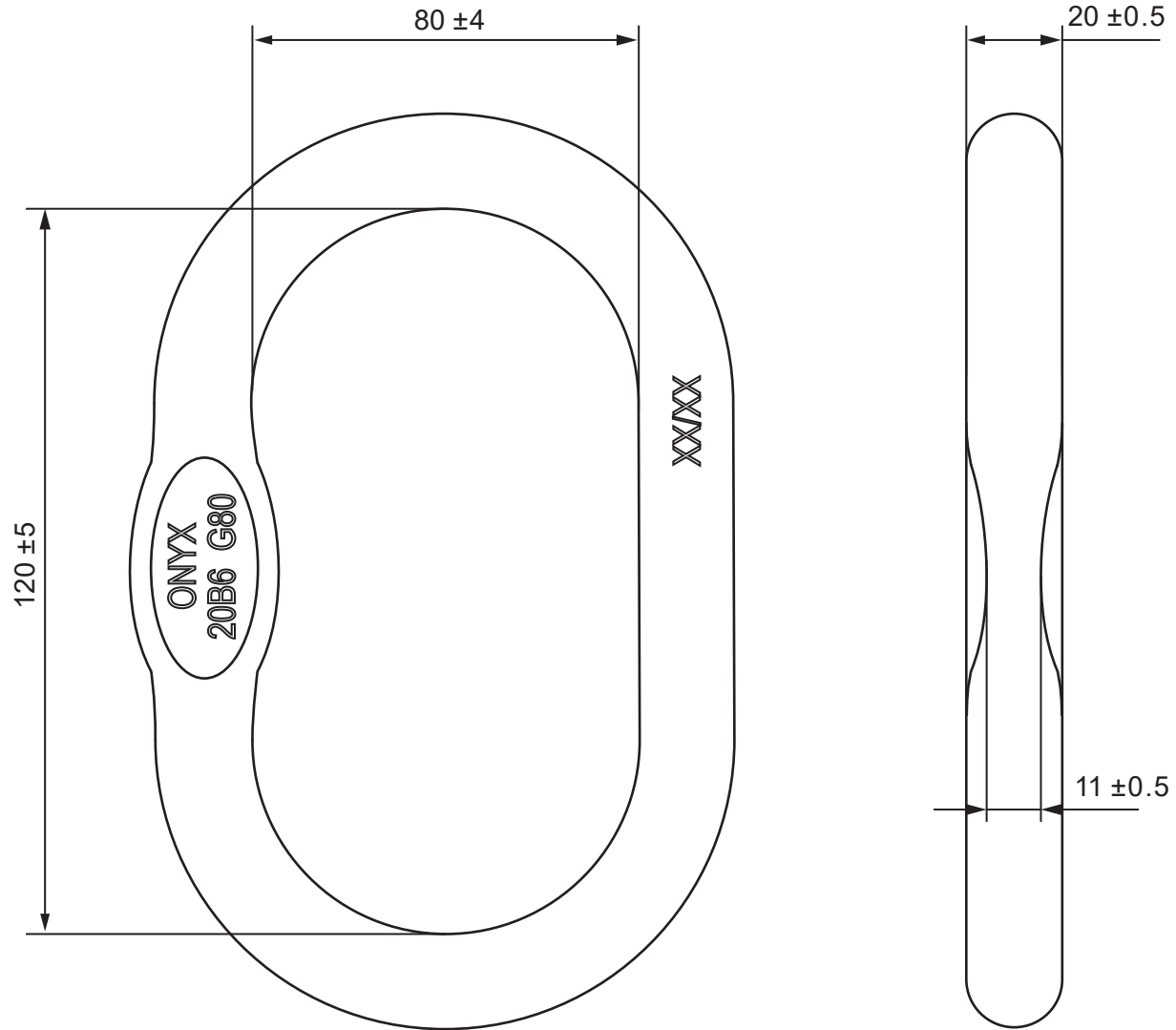

We reserve the right to make ammendments on specifications in this drawing without prior notification.

GEORGE TAYLOR LIFTING GEAR
UNIT 4, FRYERS ROAD,
WALSALL WS2 7LZ



Drawing Number
OXML20B6-GTTD

Format
A4

Drawn by
Josh Ranford

Part No. / ID
OXML20B6

Copyright by George Taylor & Co. Lifting Gear (Midlands) Ltd. All rights reserved ©.
This document or any part of it may neither be used for any purpose other than that
for which it is specifically designed, without the prior written consent of GT.

Part name:
OXML20B6

Scale
1:1.5

Page
1/1

03.11.23

First Issue