

Onyx Grade 80 Swivel Lifting Point

Code : OXSLP1090

Dia. : 10mm

**ONYX**

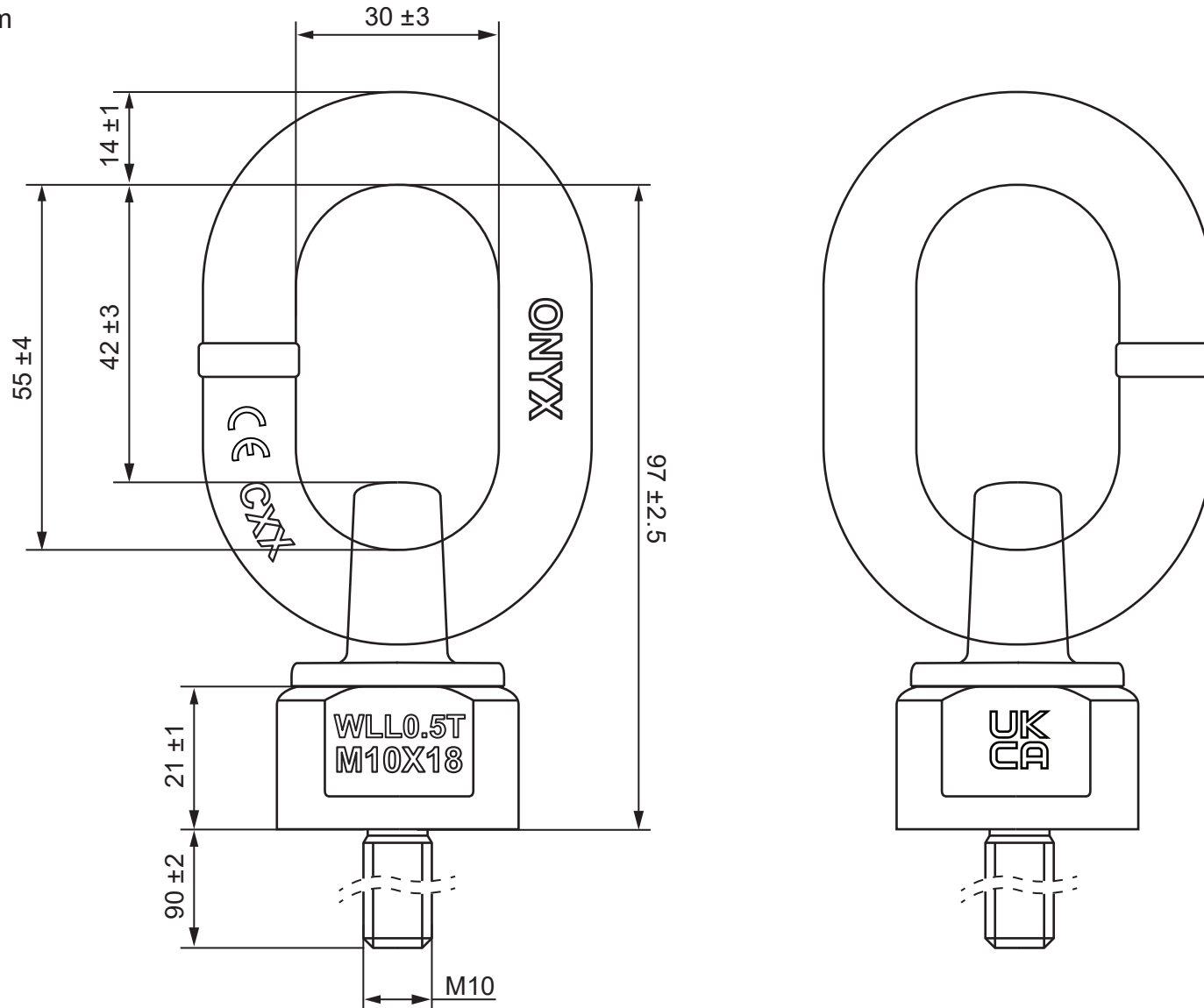

We reserve the right to make ammendments on specifications in this drawing without prior notification.

GEORGE TAYLOR LIFTING GEAR  
UNIT 4, FRYERS ROAD,  
WALSALL WS2 7LZ



Drawing Number  
**OXSLP1090-GTTD**

Format  
**A4**

Weight  
**0.5 kgs**

Drawn by  
**Josh Ranford**

Page  
**1/1**

Copyright by George Taylor & Co. Lifting Gear (Midlands) Ltd. All rights reserved ©.  
This document or any part of it may neither be used for any purpose other than that  
for which it is specifically designed, without the prior written consent of GT.

W.L.L.  
**1t 0° / 0.5t 90°**

Scale  
**1:1**

16.02.24

First Issue