

TECHNICAL SPECIFICATION

Model: SX20

Description: 20 tonne Nylon Wheeled Skates

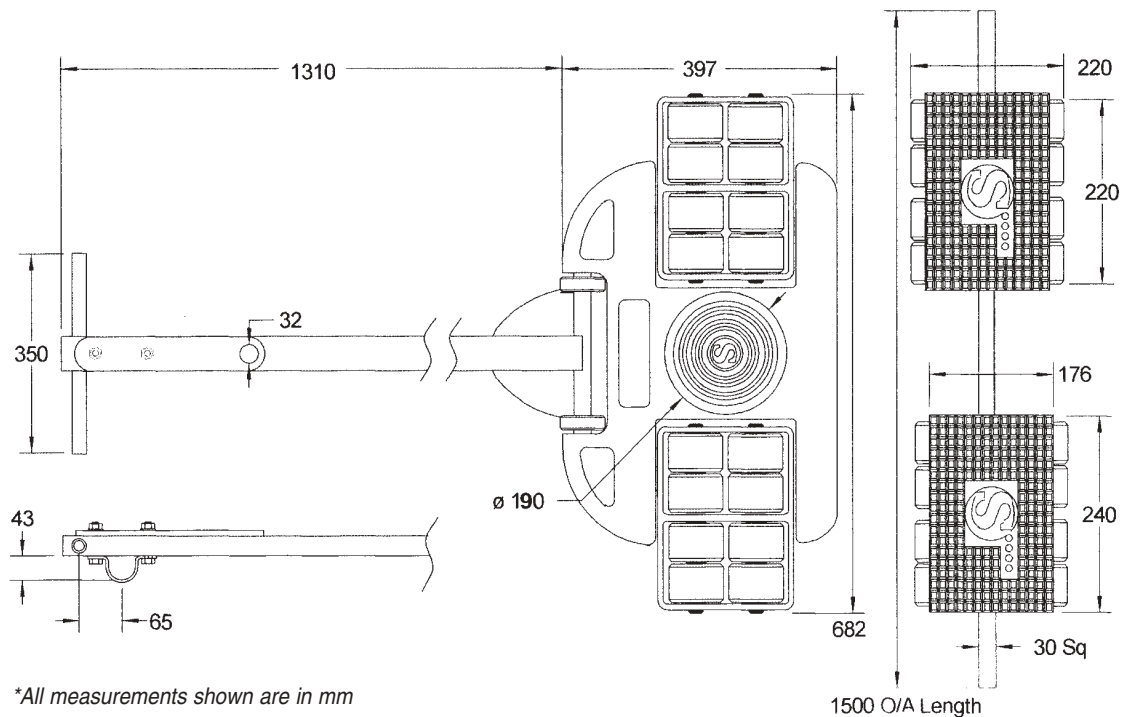

Model	Capacity of system (tonnes)	Colour and quantity of wheels	Size of wheels (mm)	Turntable diameter (mm)	Overall height (mm)	Rear width adjustment (mm)	Boxed weight (kgs)
SX20	20	Black x 32	82 x 48	190	102	480 to 1500	76

“Moving Loads the Professional Way!”