

Dimensions model CPE/CPEF

Model	CPE/CPEF 16-8	CPE/CPEF 20-8	CPE/CPEF 25-5	CPE/CPEF 30-5	CPE/CPEF 32-4	CPE/CPEF 40-4	CPE/CPEF 50-2	CPE/CPEF 75-1,6	CPE/CPEF 100-2
A3, mm	121	121	121	121	121	121	121	-	110
A4, mm	465	465	465	465	615	615	615	855	965
A5, mm	298	298	298	298	298	298	298	477	450
A6, mm	178	178	178	178	178	178	178	-	170
b, mm	A = 98 - 180/ B = 180 - 300	A = 98 - 180/ B = 180 - 300	A = 98 - 180/ B = 180 - 300	A = 98 - 180/ B = 180 - 300	A = 98 - 180/ B = 180 - 300	A = 98 - 180/ B = 180 - 300	A = 98 - 180/ B = 180 - 300	125 - 310	125 - 310
F, mm	150	150	150	150	150	150	150	113	113
l, mm	142.5	142.5	142.5	142.5	142.5	142.5	142.5	170	170
L1, mm	209	209	209	209	209	209	209	200	200
L2, mm	262.5	262.5	262.5	262.5	262.5	262.5	262.5	215	215
L3 (VTE), mm	292	292	292	292	292	292	292	-	335
L3 (VTEF), mm	296	296	296	296	296	296	296	-	335
L4, mm	213	213	213	213	253	253	253	215	390
L5, mm	312	312	312	312	272	272	272	215	215
L6 (VTE), mm	342	342	342	342	342	342	342	-	-
L6 (VTEF), mm	346	346	346	346	306	306	306	-	-
O, mm	125	125	125	125	125	125	125	150	150
P (VTE), mm	197	197	197	197	197	197	197	-	273
P (VTEF), mm	205	205	205	205	205	205	205	-	280
P1, mm	229	229	229	229	229	229	229	-	110
S, mm	b + 70	b + 70	b + 70	b + 70	b + 70	b + 70	b + 70	b + 98	b + 98
T, mm	94	94	94	94	94	94	94	-	94
tmax., mm	27	27	27	27	27	27	27	40	40

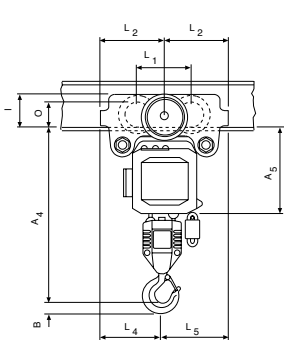

Model CPE/CPEF with integrated manual push or geared trolley

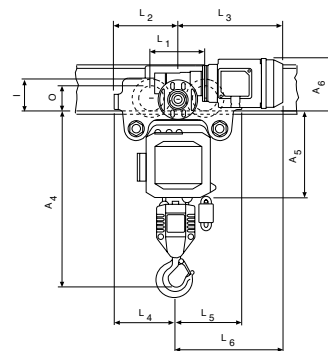
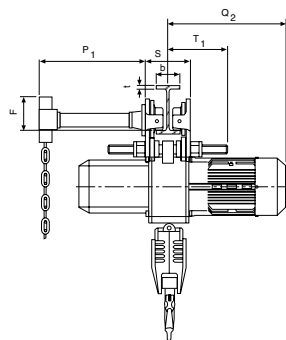

Model CPE/CPEF with integrated electric trolley

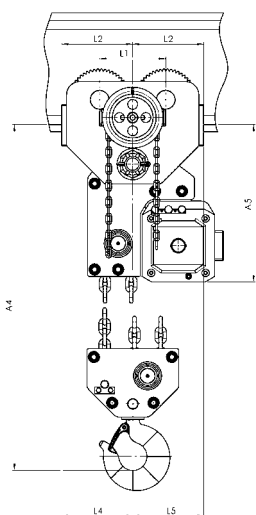
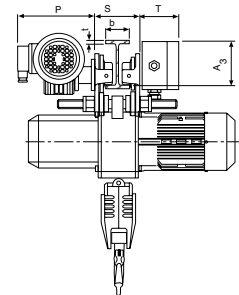

Model CPE/CPEF with integrated geared or electric trolley, 7500 kg

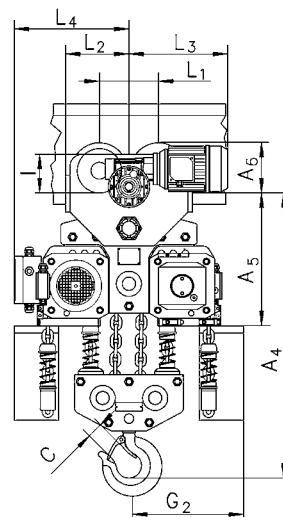
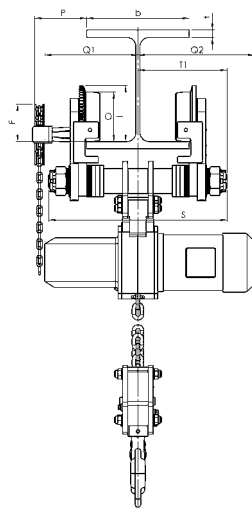

Model CPE/CPEF with integrated electric trolley, 10000 kg

