

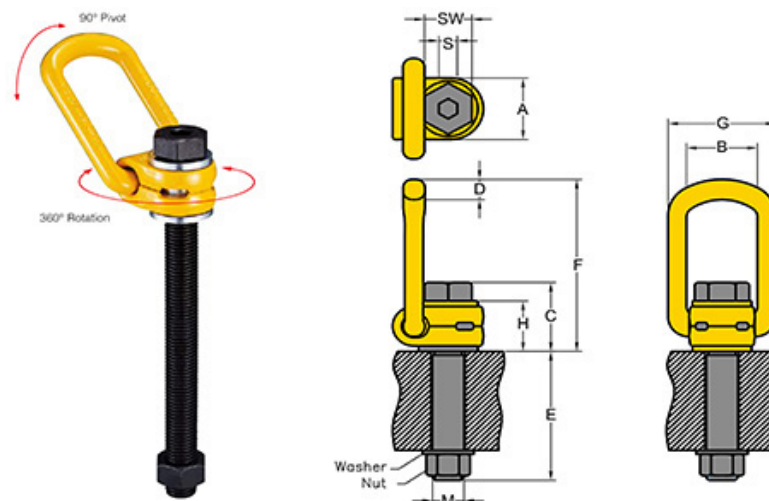











## Yoke Lifting Point Long Bolt - type 211 metric thread

- Rotates through 360° and pivots 90°.
- Manufactured from alloy steel, quenched and tempered.
- Manufactured and tested in accordance with EN1677-1.
- Load rated parts are 100% magnaflux crack detected.
- Individual forged parts and cap screw are traceable to Test Certification.
- Bolts are Metric thread (ASME / ANSI B18.3.1M).
- Proof tested to 2.5 times the WLL.
- Fatigue rated to 1.5 times the WLL.
- Design Factor 4 : 1
- All YOKE Lifting points meet or exceed all the requirements of ASME B30.26.
- Quick and simple assembly, just a tapped hole is required.



Part Code	WLL tonnes	Thread M mm	Thread E mm	Thread Pitch DIN13	A mm	B mm	C mm	D mm	F mm	G mm	H mm	S mm	SW mm	Torque in Nm	Mass kg
8-211-003/105L	0.3	M8	76	1.25	30	35	35	10	85	55	29	6	13	30	0.3
8-211-006/125L	0.63	M10	96	1.5	30	35	36	10	85	55	29	6	17	60	0.4
8-211-010/150L	1	M12	114	1.75	33	37	44	14	98	57	36	8	19	100	0.6
8-211-015/185L	1.5	M16	149	2	33	37	46	14	98	57	36	10	24	150	0.7
8-211-025/230L	2.5	M20	186	2.5	50	54	57	17	140	82	44	12	30	250	1.7
8-211-040/265L	4	M24	221	3	50	54	59	17	140	82	44	14	36	400	2.1
8-211-050/340L	5	M30	278	3.5	60	65	81	23	170	99	62	17	46	500	4.3
8-211-080/300L	8	M36	222	4	77	85	101	27	225	124	78	22	55	800	7.3
8-211-100/350L	10	M42	272	4.5	77	85	104	27	225	124	78	24	65	1000	8.7
8-211-150/350L	15	M42	264	4.5	95	104	112	36	256	158	86	24	65	1500	13.1
8-211-200/385L	20	M48	295	5	95	104	120	36	259	158	90	27	75	2000	15.2

# LIFTING POINT LONG BOLT WORKING LOAD APPLICATION FACTORS

											
Number of legs		1	2	1	2	2	2	2	3-4	3-4	3-4
Load Direction	0°	0°	90°	90°	0-45°	45-60°	unsymm.	0-45°	45-60°	unsymm.	
Part Code	Thread	WLL Tonnes									
8-211-003/105L	M8	0.3	0.6	0.3	0.6	0.42	0.3	0.3	0.63	0.45	0.3
8-211-006/125L	M10	0.63	1.26	0.63	1.26	0.88	0.63	0.63	1.32	0.95	0.63
8-211-010/150L	M12	1	2	1	2	1.4	1	1	2.1	1.5	1
8-211-015/185L	M16	1.5	3	1.5	3	2.1	1.5	1.5	3.1	2.2	1.5
8-211-025/230L	M20	2.5	5	2.5	5	3.5	2.5	2.5	5.2	3.7	2.5
8-211-040/265L	M24	4	8	4	8	5.6	4	4	8.4	6	4
8-211-050/340L	M30	5	10	5	10	7	5	5	10.5	7.5	5
8-211-080/300L	M36	8	16	8	16	11.2	8	8	16.8	12	8
8-211-100/350L	M42	10	20	10	20	14	10	10	21	15	10
8-211-150/350L	M42	15	30	15	30	21	15	15	31.5	22.5	15
8-211-200/385L	M48	20	40	20	40	28	20	20	42	30	20